

Article number: 0101202
 Description: Retaining ring A 320 DIN 471
 Spring steel
 Note: Fitted with ZGA pilers

Measures

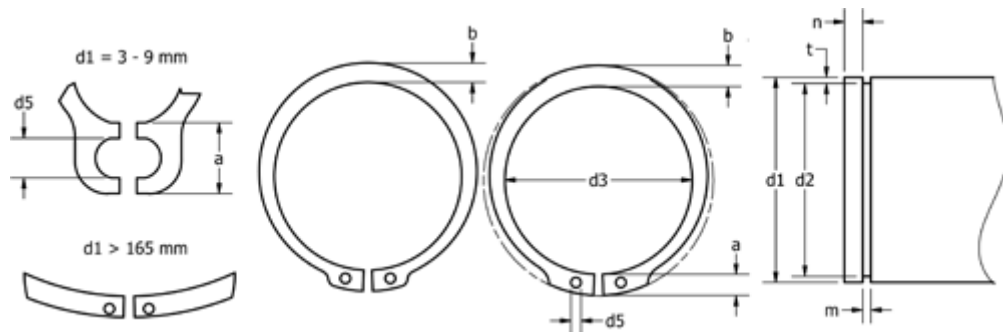

a max	=	FN kN	= 825.0	s	= 6.00
AN mm ²	= 4950.0	FRg kN	= 85.00	t	= 5.00
b	= 20.0	FR kN	= 998.00	tol	= -0.81
d1	= 320	g	= 7.0	tol	= -0.15
d2	= 310.0	K kN-mm	= 2264.00	tol	= +0,81-2,00
d3	= 303.0	m min	= 6.20	Tong	= ZGA-6
d5 min	= 6.0	n abl x 1000	= 1.0	Weight kg/1000	= 770.000
Description	= A320	Nominal drive	= 15.0		